

SNC-VM631

Network Mini Dome FHD Camera – V Series

SONY
make.believe

Vandal-resistant Mini Dome 1080/60p Camera Powered by IPELA ENGINE EX™

- Maximum resolution of 1920 x 1080 pixels with the Exmor™ CMOS sensor
- High frame rate of 60 frames per second (fps)
- Dynamic range equivalent to 90 dB achieved with View-DR technology
- Scene analytics enhanced by unique features such as face detection
- H.264 (High/Main/Baseline Profile)/JPEG video codecs and AAC (16 kHz/48 kHz)/G.726/G.711 audio codecs
- Minimum illumination of 0.1 lx in Color mode and 0.07 lx in B/W mode at 50 IRE and 30 fps
- IK10-rated vandal-resistant feature



KEY FEATURES

- IPELA ENGINE EX signal processing system developed based on Sony's unique signal processing and video analytics technologies to provide unique features such as a high frame rate, View-DR, XDNR, and DEPA™ Advanced



- High frame rate of 60 fps to provide smoother and less blurry moving pictures
- View-DR – Sony's innovative wide dynamic range technology – to capture objects clearly and adaptively even under very harsh, severe backlight or highlight conditions

View-DR



OFF

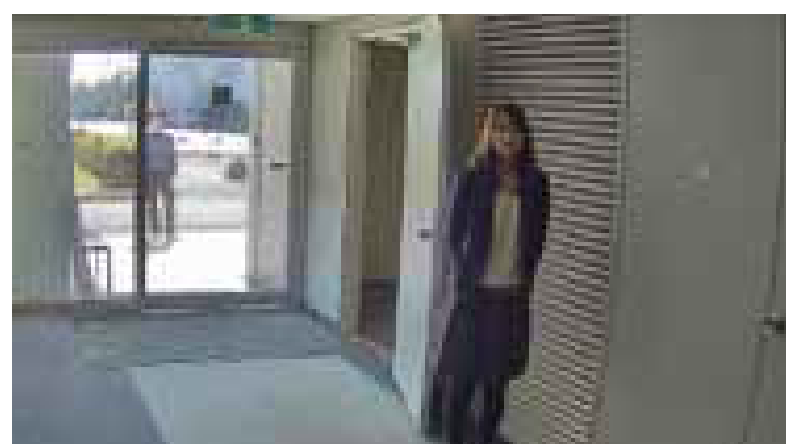

ON

Actual Images

- Visibility Enhancer (VE) to optimize the brightness and color reproduction of an image dynamically on a pixel-by-pixel basis while continuously adapting to the scene within the given dynamic range
- DEPA Advanced Intelligent Video and Audio Analytics to trigger an alarm based on user-defined rules



- XDNR (eXcellent Dynamic Noise Reduction) technology for clear images without motion blur under low illumination

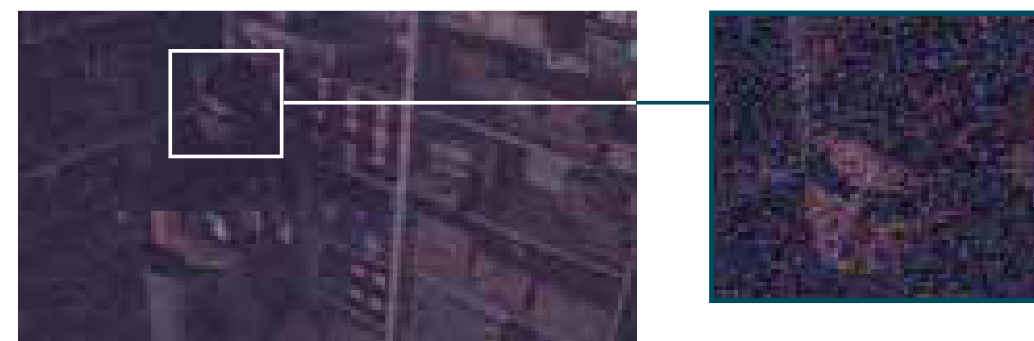

OFF

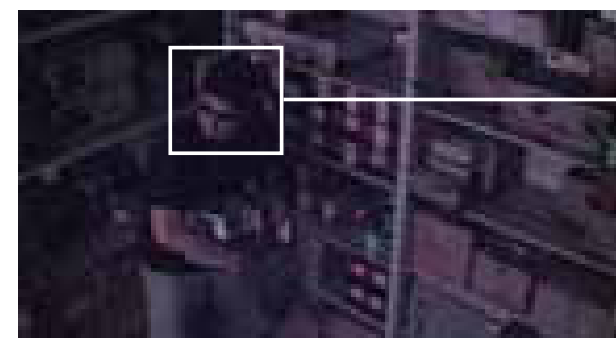

ON

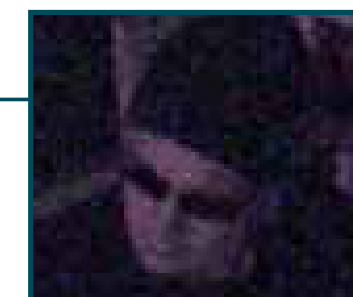

Actual Images

- IK10-rated vandal-resistant feature to protect the camera from destructive behaviors
- SD card slot for an on-board recording capability*
- True D/N (Day/Night) function to switch to Day or Night mode depending on the light level
- Smartphone Viewer for accessing the camera from a smartphone
- Easy Focus/Easy Zoom for easy installation
- Powered by either PoE (IEEE 802.3af-compliant), AC 24 V ±20%, or DC 12 V ±10% for easy installation
- ONVIF (Open Network Video Interface Forum) Profile S conformance 
- VBR (variable bitrate) or CBR (constant bitrate) encoding format selectable to correspond with various network conditions
- Easy initial network settings by supplied SNC Easy IP Setup Guide application
- Image Stabilizer to minimize the effect of camera shake or vibration for less blurry images

* Data recorded on an SD memory card may be lost or damaged by data access during power-off, mechanical shock, memory card detachment, or other operations. Data loss or damage can also occur when a memory card reaches end of life, which varies according to operational conditions. No guarantee is given against damage (including passive damage).

Connect Your Vision

IPELA™

SPECIFICATIONS

SNC-VM631	
Camera	
Image Sensor	1/2.9-type progressive scan Exmor CMOS sensor
Image Sensor (Number of Effective Pixels)	Approx. 2.14 Megapixels
Signal System	NTSC color system / PAL color system (switchable)
Minimum Illumination (50 IRE)	Color: 0.1 lx (F1.2, View-DR OFF, VE OFF, AGC ON, 1/30 s, 30 fps) B/W: 0.07 lx (F1.2, View-DR OFF, VE OFF, AGC ON, 1/30 s, 30 fps)
Minimum Illumination (30 IRE)	Color: 0.06 lx (F1.2, View-DR OFF, VE OFF, AGC ON, 1/30 s, 30 fps) B/W: 0.05 lx (F1.2, View-DR OFF, VE OFF, AGC ON, 1/30 s, 30 fps)
Dynamic Range	Equivalent to 90 dB with View-DR technology
S/N Ratio	More than 50 dB (Gain 0 dB)
Gain	Auto
Shutter Speed	1/1 s to 1/10000 s
Sync System	Internal synchronization
Exposure Control	Exposure compensation, AGC, Shutter speed, Iris
White Balance	ATW, ATW-PRO, Fluorescent lamp, Mercury lamp, Sodium vapour lamp, Metal halide lamp, White LED, One push WB, Manual
Lens	Built-in varifocal lens
Powered Zoom	Yes (Easy Zoom)
Zoom Ratio	Optical zoom 3x, Digital zoom 2x *3
Powered Focus	Yes (Easy Focus)
Horizontal Viewing Angle	105.2 ° to 35.4 °
Vertical Viewing Angle	57 ° to 20 °
Focal Length	f = 3.0 mm to 9.0 mm
F-Number	F1.2 (Wide), F2.1 (Tele)
Minimum Object Distance	300 mm
Horizontal Resolution	700 TV lines (analog video) *2
Preset Position	8
Tour	5
Camera Features	
Day/Night	Yes
Wide-D	Yes (View-DR)
Image Enhancement	Visibility Enhancer (VE)
Noise Reduction	XDNR
Image Stabilizer	Yes *3 *6
Image	
Codec Image Size (H x V)	1920 x 1080, 1280 x 720, 1024 x 576, 720 x 576, 720 x 480, 704 x 576, 640 x 480, 640 x 360, 352 x 288, 320 x 184 (H.264, JPEG)
Video Compression Format	H.264 (High/Main/Baseline Profile), JPEG
Codec Streaming Capability	Triple Streaming *1, CBR/VBR (selectable) *4
Maximum Frame Rate	H.264: 60 fps (1920 x 1080) JPEG: 60 fps (1280 x 720)
Audio	
Audio Compression Format	G.711/G.726/AAC (16 kHz, 48 kHz)
Scene Analytics	
Intelligent Motion Detection	Yes
Face Detection	Yes *5
Rule-based Filter	DEPA Advanced *3
Network	
Protocols	IPv4, TCP, UDP, ARP, ICMP, IGMP, HTTP, DHCP, DNS, NTP, RTP/RTCP, RTSP, SMTP, IPv6 *6, HTTPS *4, SNMP (MIB-2) *4
ONVIF Conformance	Yes (Profile S) *5
Number of Clients	20
Authentication	IEEE 802.1X *4
Interface	
Analog Video Output	BNC x1, 1.0 Vp-p, 75 Ω, unbalance, sync negative
Analog Monitor Output	Phono jack x1
Line Input	Mini jack (monaural)
Line Output	Mini jack (monaural), Maximum output level: 1 Vrms
Network Port	10BASE-T/100BASE-TX (RJ-45)
Sensor Input	x 2, make contact, break contact
Alarm Output	x 2, 24 V AC/DC, 1 A (mechanical relay outputs electrically isolated from the camera)
Microphone Input	Mini jack (monaural)
Card Slots	SD Card x 1
System Requirements	
Operating System	Windows XP (32 bit) Professional Edition Windows Vista (32 bit) Ultimate, Business Edition Windows 7 (32/64 bit) Ultimate, Professional Edition
Processor	Intel Core i7 2.8 GHz or higher
Memory	2 GB or more
Web Browser	Microsoft Internet Explorer Ver. 7.0, Ver. 8.0, Ver. 9.0 Firefox Ver. 3.5 (Plug-in free viewer only) Safari Ver. 4.0 (Plug-in free viewer only) Google Chrome Ver. 4.0 (Plug-in free viewer only)
General	
Power Requirements	PoE system (IEEE 802.3af compliant), DC 12 V ± 10%, AC 24 V ± 20%
Power Consumption	6.0 W max.
Operating Temperature	-10 °C to +50 °C (14 °F to 122 °F)
Starting Temperature	0 °C to 50 °C (32 °F to 122 °F)
Storage Temperature	-20 °C to +60 °C (-4 °F to +140 °F)
Operating Humidity	20% to 80%
Storage Humidity	20% to 95%
Vandal Resistant	Yes
Dimensions (W x H x D)	ø148 x 108 mm (ø5 7/8 inches x 4 3/8 inches)
Mass	Approx. 800 g (1 lb 12 oz)
Safety Regulations	JATE Technical standard (LAN) UL2044, IEC60950-1 (CB) VCCI (Class A), FCC (Class A), IC (Class A) Emission: EN55022 (Class A) + EN50130-4 Immunity: EN55022 (Class A) + EN55024 Emission: AS/NZS CISPR22 (Class A)
Supplied Accessories	CD-ROM (supplied programs) (1), Installation Manual (1), Template (1), Audio cable (1), I/O cable (1), BNC cable (1), Power input cable (1), Screw M3 (1), Wrench (1), Bracket (1), Wire rope (1), Safety regulations (1)

*1 Triple streaming (any combination with JPEG/H.264, including multiple streams of the same format)

*2 Monitor display ratio 4:3 *3 Version 1.2 or later *4 Version 1.3 or later *5 Version 1.4 or later *6 Default setting: OFF

SYSTEM CONFIGURATION

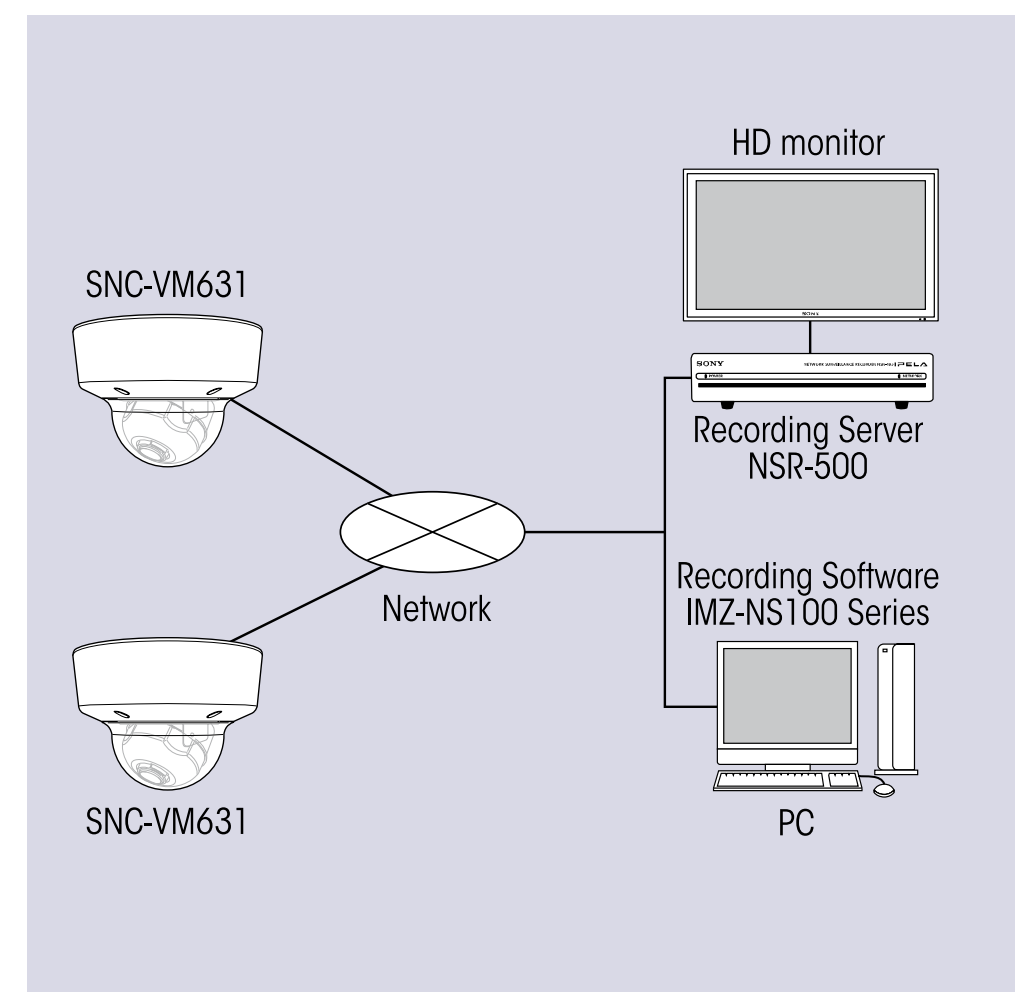

DIMENSIONS

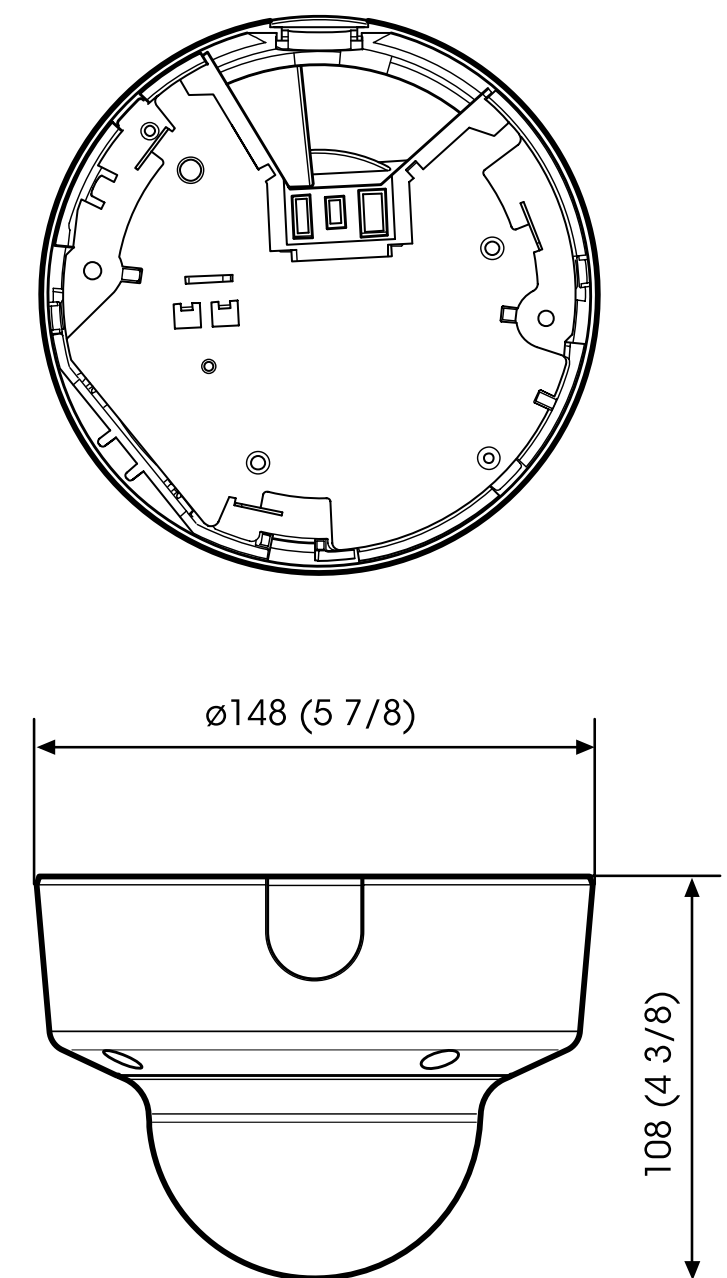

Unit: mm (inches)

Distributed by



www.use-ip.co.uk
01304 827609

©2012 Sony Corporation. All rights reserved.

Reproduction in whole or in part without permission is prohibited. Features and specifications are subject to change without notice.

The values for mass and dimension are approximate.

"Sony", "make.believe", "IPELA", "IPELA ENGINE EX", "Exmor", and "DEPA" are trademarks of Sony Corporation.

All other trademarks are the properties of their respective owners.